

接触子先端

KCS-R2

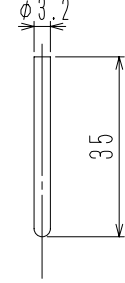

KCS-OY2

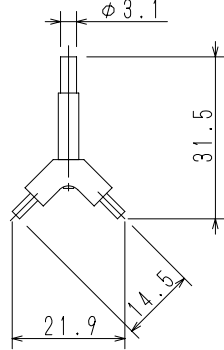

KCS-IY2

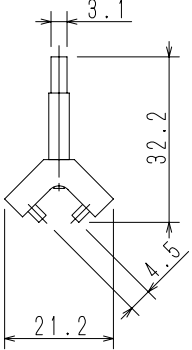

KCS-OF2

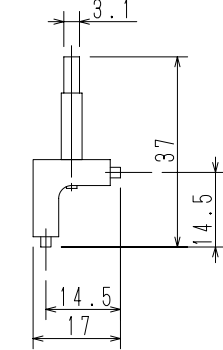

KCS-IF2

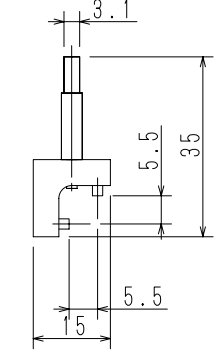

KCS-S2

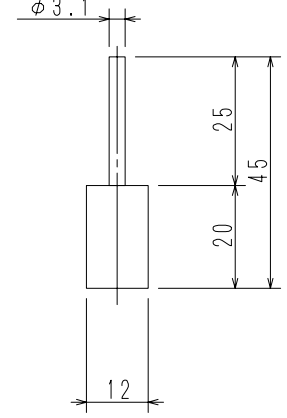

KCS-OY2L

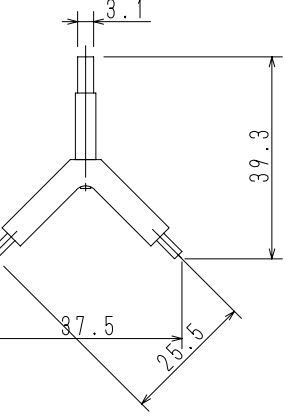

特殊接触子先端

KCS-CU08

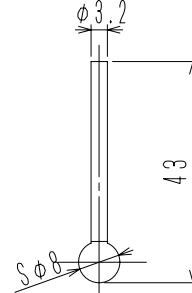

KCS-CU10

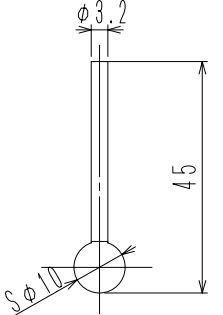

KCS-CU13

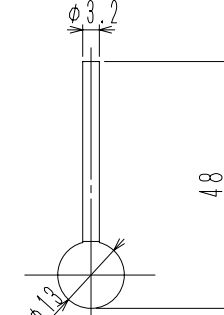

特殊接触子

KCS-W2

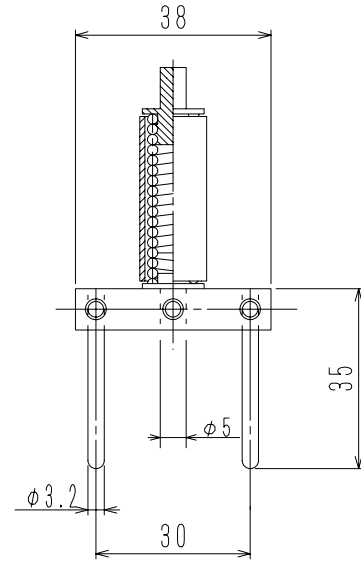

KCS-W3

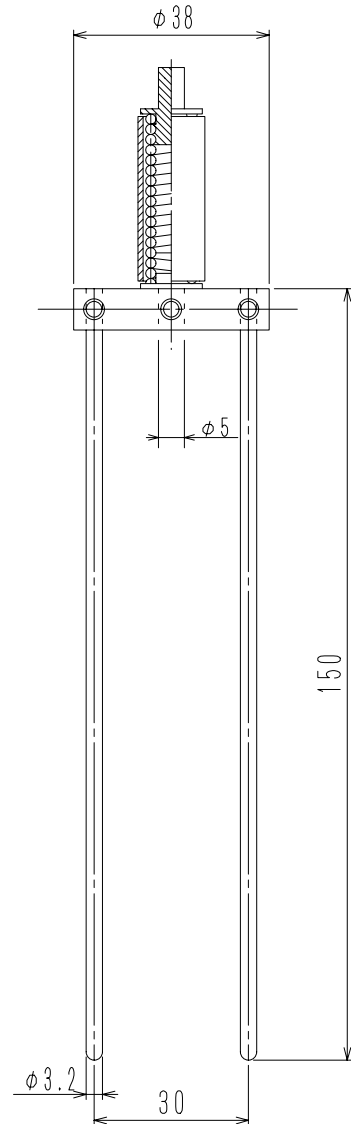

KCS-W4

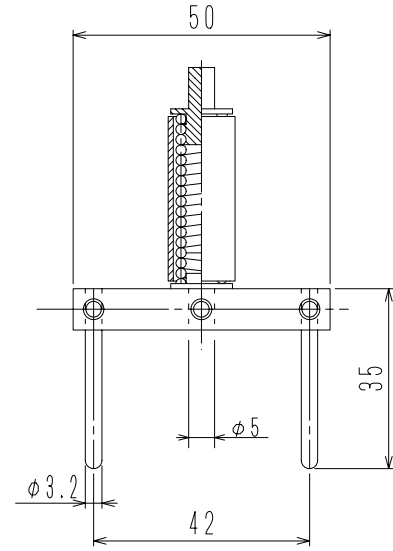

KCS-W5

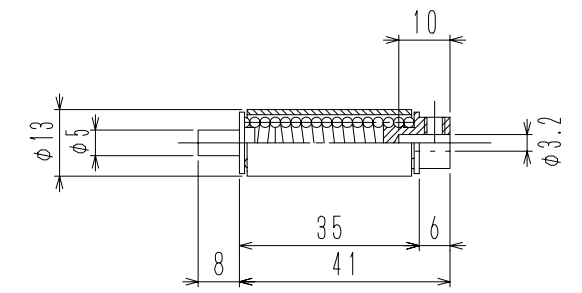
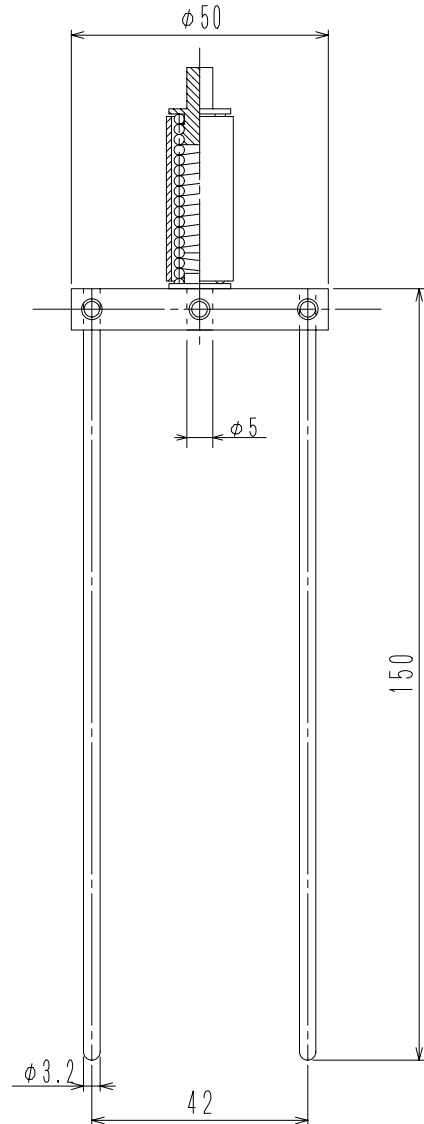

KCS-H13
(接触子先端及び特種接触子先端用)

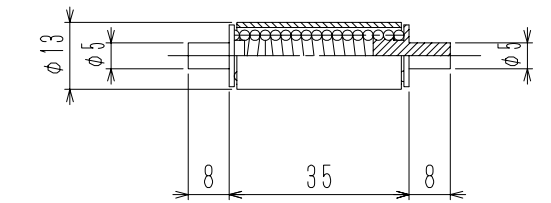

KCS-H14
(特種接触子用)

番号	名称	规格・材質	数	備考
製番	KCS-	名称 接触子・接触子先端		
日付	2002.02.22	図名		外形図
図番		KILONY		キロニー産業株式会社